

# Product Portfolio Overview

## Flexible Packaging

EUROPE | MIDDLE EAST | AFRICA | ASIA PACIFIC





# Product Portfolio Overview

## Flexible Packaging

Product descriptions, key markets and packaging formats

**Jindal**  
Films



### Bicor™

ORIENTED POLYPROPYLENE

Transparent Films

#### Uncoated

MB400, MB090, GND, GEA, HNA, HND, HLD, CSRM, GNR, NNA, NND, NNH, MB100, MR100, MR103, MB344US

#### Coated

MB600/MB621, MB666, MB602, ICT, CLH, COS5, MB777, COS, MBX768, MB668, MBH668, MBH568, MB866, MB890

■ Page 2

### OPPalyte™

ORIENTED POLYPROPYLENE

White Films

#### Uncoated

SHD/SHH, MH247, MW247, ICE, DO447, HGP, MD447, WTD, STD, VLD, SVD

#### Coated

MW647, MH647, MO747, MW747, MW648, MH648

■ Page 14

### Metallyte™

ORIENTED POLYPROPYLENE

Metallized Films

#### Clear

MM480, MM488, MM280, MM388, MM398, MLB, MM288, MM883, MML883

#### White

ICEM, MW280, MW480, MHO280, MU842, QFM, UBWES

■ Page 21

### Alox-Lyte™

ORIENTED POLYPROPYLENE

Transparent High Barrier Vacuum Coated Films

AO893, AO894, AOL893 ■ Page 27

### SeaITOUGH™

ORIENTED POLYETHYLENE FILMS

XE400 ■ Page 28

### Ethy-Lyte™

ORIENTED HIGH DENSITY POLYETHYLENE FILMS

HD200, HD240, HD235, HD213, HD800, HD813, HDM880 ■ Page 29

## MB400

Transparent BOPP film one side treated, sealable coextruded film, designed for use in lamination.

**Key Markets :** Biscuits, Baked Goods, Chocolate Confectionery, Frozen Food, Salty Snacks, Crisps, Dry Pet Food, Health & Beauty Aid, Household Products.

**Packaging Formats :** HFFS, VFFS, OW.

## MB400

Transparent BOPP film with one side treated and two sides heat sealable with controlled slip, designed to be used as a single web or in laminations.

**Key Markets :** Biscuits, Baked Goods, Chocolate Confectionery, Frozen Food, Salty Snacks, Crisps, Dry Pet Food, Health & Beauty Aid, Household Products.

**Packaging Formats :** HFFS, VFFS, OW, Pre-made Bags, Sachets.

## MB090

Transparent BOPP film metalizable on the treated side, with a slip controlled broad seal range surface on the other side, designed to be used in laminates as the inner web.

**Key Markets :** Base film for metallization.

**Packaging Formats :** HFFS, VFFS.

Thickness (µm)	Unit Weight (g/m <sup>2</sup> )	WVTR (g/m <sup>2</sup> /day)	CoF	Heat Seal Range (Untreated °C)
15	13,7	7,7	0,30	40*
17	15,5	7,7	0,30	40*
20	18,2	7,0	0,30	40*

Thickness (µm)	Unit Weight (g/m <sup>2</sup> )	WVTR (g/m <sup>2</sup> /day)	CoF	Heat Seal Range (Treated; Untreated °C)
25	22,8	5,0	0,30	35 / 40*
30	27,3	4,5	0,30	35 / 40*
35	31,9	4,0	0,30	35 / 40*
40	36,4	3,5	0,30	35 / 40*
50	45,5	3,0	0,30	35 / 40*

Thickness (µm)	Unit Weight (g/m <sup>2</sup> )	CoF (BSR)	Heat Seal Range (BSR °C)
18	16,4	0,40	40*

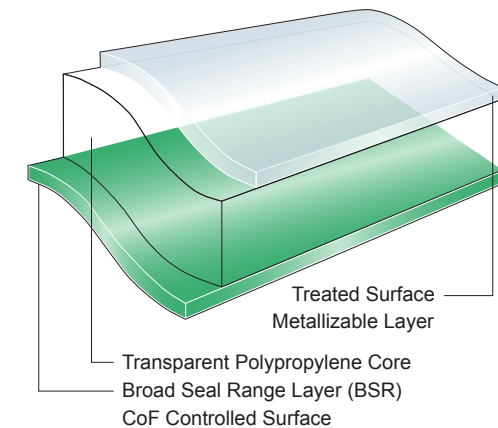
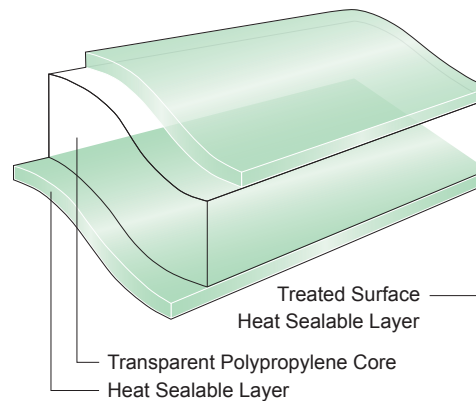
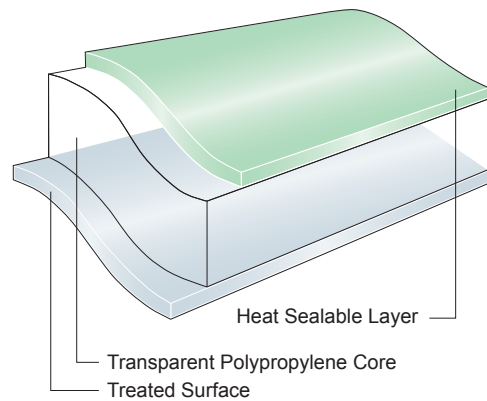



## GND

Transparent, two side heat sealable, one side treated BOPP film. Its consistent slip and seal integrity allow GND to be used for a wide variety of processes. Lap sealable in lamination.

**Key Markets :** Chocolate Confectionery, Biscuits, Baked Goods, Frozen Food, Health & Beauty Aid, Detergents, Salty Snacks, Crisps, Dry Pet Food, Ice Cream, Household Products, Gum.

**Packaging Formats :** HFFS, VFFS, OW, Pre-made Bags, Sachets.

Thickness (µm)	Unit Weight (g/m <sup>2</sup> )	WVTR (g/m <sup>2</sup> /day)	CoF (treated/untreated)	Heat Seal Range (Untreated °C)
20	18,2	6,8	0,35 / 0,30	30**
25	22,8	5,5	0,35 / 0,30	30**
30	27,3	4,6	0,35 / 0,30	30**

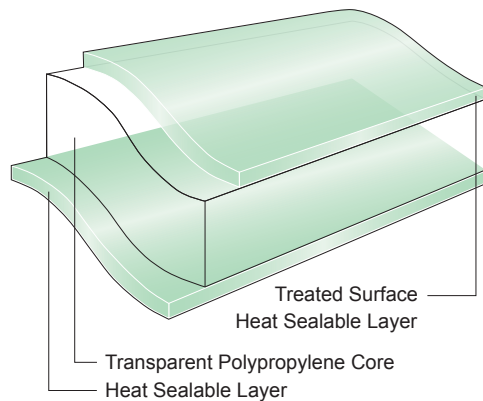

## GEA

Transparent, two side heat sealable untreated BOPP film for overwrapping. Its tailored slip properties make it particularly suitable for high speed overwrapping applications.

**Key Markets :** Household Products, Health & Beauty Aid, Detergents, Biscuits, Baked Goods, Industrial, Sweet Confectionery.

**Packaging Formats :** HFFS, OW.

Thickness (µm)	Unit Weight (g/m <sup>2</sup> )	WVTR (g/m <sup>2</sup> /day)	CoF	Heat Seal Range (Untreated °C)
25	22,8	5,5	0,40	20**

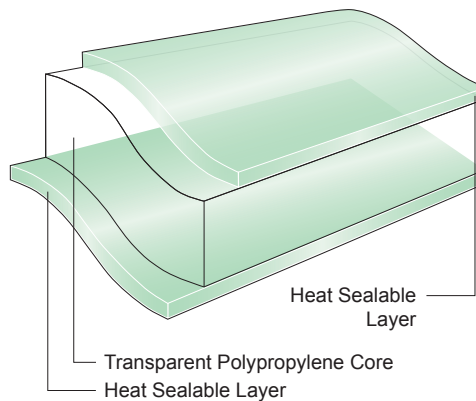

## HNA

Transparent, one side low heat sealable (90°C), one side heat sealable untreated BOPP film. Wide seal range for high speed applications whilst retaining good hot tack and seal integrity.

**Key Markets :** Biscuits, Baked Goods, Sweet Confectionery, Home & Personal Care, Detergents.

**Packaging Formats :** HFFS, OW.

## HND

Transparent, one side low heat sealable (90°C), one side heat sealable untreated BOPP film. Wide seal range for high speed applications whilst retaining good hot tack and seal integrity.

**Key Markets :** Biscuits, Baked Goods, Sweet Confectionery, Home & Personal Care, Detergents.

**Packaging Formats :** HFFS, OW.

## HLD

Transparent, one side very low heat sealable (80°C), one side treated, heat sealable BOPP film. It has an ultra low heat seal threshold sealing layer, as well as tailored and controlled slip properties to further enhance its high speed running capabilities.

**Key Markets :** Biscuits, Baked Goods, Sweet Confectionery, Home & Personal Care, Detergents.

**Packaging Formats :** HFFS, OW.

Thickness (µm)	Unit Weight (g/m <sup>2</sup> )	WVTR (g/m <sup>2</sup> /day)	Heat Seal Range (BSR °C)
25	22,8	5,5	50**
30	27,3	4,6	50**

Thickness (µm)	Unit Weight (g/m <sup>2</sup> )	WVTR (g/m <sup>2</sup> /day)	Heat Seal Range (BSR °C)
20	18,2	6,8	50**
25	22,8	5,5	50**
30	27,3	4,6	50**

Thickness (µm)	Unit Weight (g/m <sup>2</sup> )	WVTR (g/m <sup>2</sup> /day)	Heat Seal Range (VBSR °C)
20	18,2	6,8	60**
25	22,8	5,5	60**
30	27,3	4,6	60**

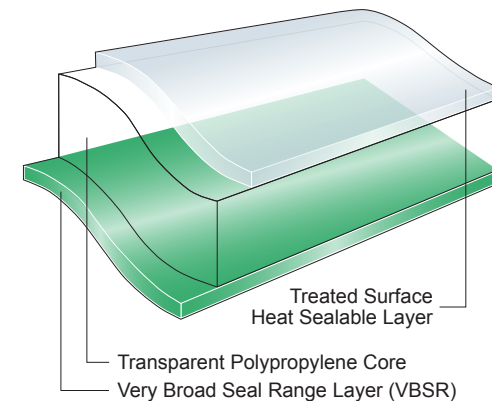
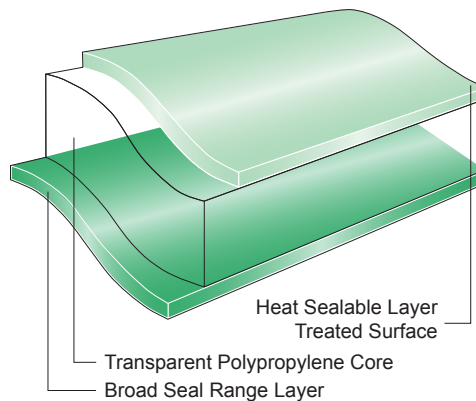
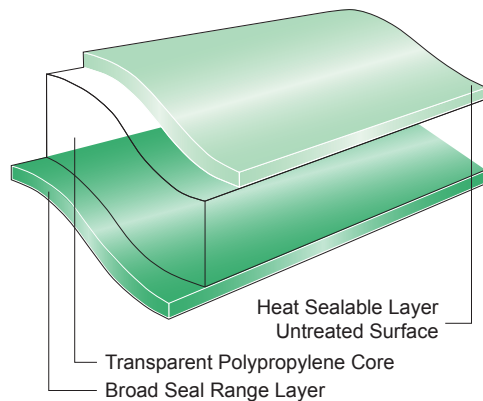

## CSRM

Transparent BOPP film, one side treated, non-heat sealable, designed for cold seal release as the outer web of a lamination. Excellent matt finish slip film, optionally for heat seal laminations. Paper-like appearance, with a satin appearance when reverse printed.

**Key Markets :** Biscuits, Baked Goods, Sweet Confectionery, Ice Cream.

**Packaging Formats :** HFFS.

Thickness (µm)	Unit Weight (g/m <sup>2</sup> )	Gloss 45° (matt side)	CoF (matt/matt)
18	16,4	13	0,35
25	22,9	13	0,40

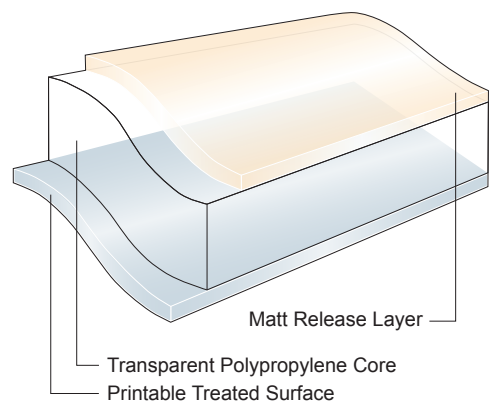

## GNR

Matt transparent, heat sealable, one side treated BOPP film. This film offers a wide range of design options due to its matt surface. For laminates with matt look.

**Key Markets :** Salty Snacks, Sweet Confectionery, Biscuits, Baked Goods, Frozen Food, Coffee.

**Packaging Formats :** HFFS, VFFS, Pouches, Stand-up Pouches.

Thickness (µm)	Unit Weight (g/m <sup>2</sup> )	Gloss 60° (matt side)	CoF (matt/matt)	Heat Seal Range (matt °C)
20	17,6	12	0,30	50*
30	26,4	12	0,30	50*

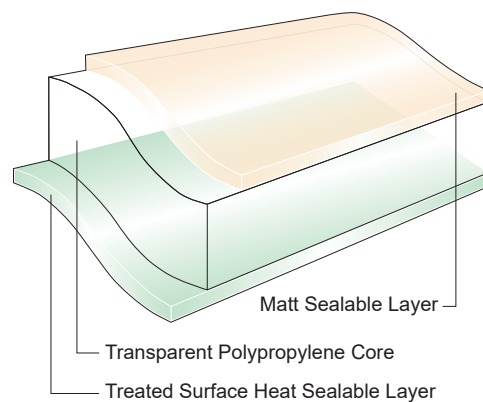

## NNA

High gloss, untreated, transparent BOPP film. Release film for surface protection of other materials.

**Key Markets :** Industrial, Flowers.

**Packaging Formats :** -

## NND

High gloss, non heat sealable, one side treated, transparent BOPP film. Cold seal release film for high gloss lamination.

**Key Markets :** Chocolate Confectionery, Biscuits, Baked Goods, Ice Cream, Dry Foods, Dry Beverages.

**Packaging Formats :** HFFS, VFFS, Stand-up Pouches, Pouches.

## NNH

High gloss, non heat sealable, both sides treated, transparent BOPP film. Cold seal release film for high gloss lamination. A lacquer can be applied on the treated glossy layer.

**Key Markets :** Chocolate Confectionery, Biscuits, Baked Goods, Ice Cream.

**Packaging Formats :** HFFS, VFFS, Stand-up Pouches, Pouches.

Thickness (µm)	Unit Weight (g/m <sup>2</sup> )	Gloss 20° (Release Layer)	CoF (Release Layer)
20	18,2	140	0,35

Thickness (µm)	Unit Weight (g/m <sup>2</sup> )	Gloss 20° (Release Layer)	CoF (Release Layer)
12	10,9	140	0,38 / 0,40
20	18,2	140	0,38 / 0,40
25	22,8	140	0,38 / 0,40

Thickness (µm)	Unit Weight (g/m <sup>2</sup> )	Gloss 20° (Release Layer)	CoF (Release Layer)
20	18,2	135	0,38

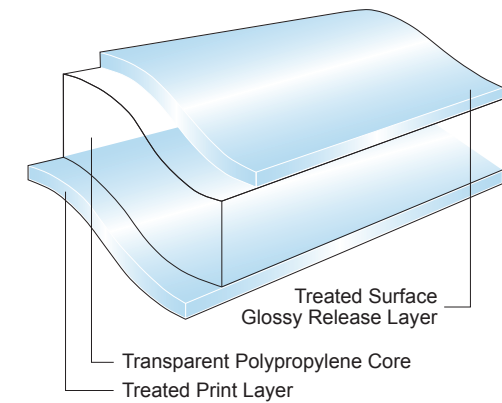
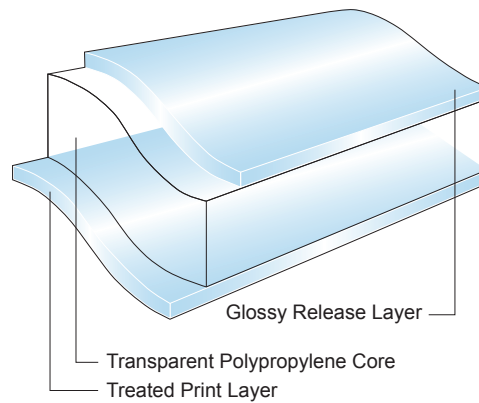
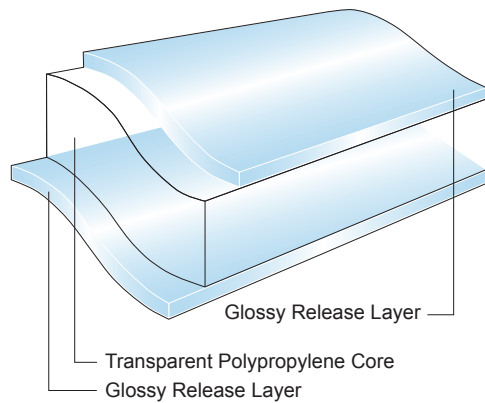

## MB100

1-side treated clear non-sealable OPP film with improved heat stability and stiffness compared to standard OPP. Designed for reverse printing as the outer web of a lamination, to help replace thin PET films and achieve monomaterial PP rich or mixed polyolefin (PO) structures for improved recyclability of flexibles.

**Key Markets :** Biscuits, Baked Goods, Confectionery, Home & Personal Care, Dry foods, Dry Beverages, Dry Pet Care.

**Packaging Formats :** VFFS, HFFS, Stand-Up Pouches, Flat Sachets, Pouches, Pre-made Bags.

Thickness (µm)	Unit Weight (g/m <sup>2</sup> )	Gloss 20° (Release Layer)	CoF (Release Layer)
12	10,9	120	0,40

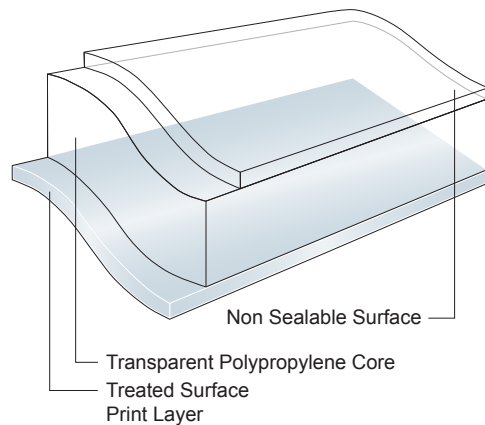

## MR100

1-side treated clear non heat sealable OPP film with improved heat stability to be considered for thermal processing applications (such as retorted or sterilized products). Designed for reverse printing as the outer web of a barrier laminate to help replace PET films and achieve mono-material PP-rich structures.

**Key Markets :** Wet Pet Care, Home Meal Replacements.

**Packaging Formats :** VFFS, Stand-up Pouches, Flat Sachets, Pouches, Pre-made Bags.

Thickness (µm)	Unit Weight (g/m <sup>2</sup> )	Gloss 20° (Release Layer)	CoF (Release Layer)
25	18,2	120	0,40

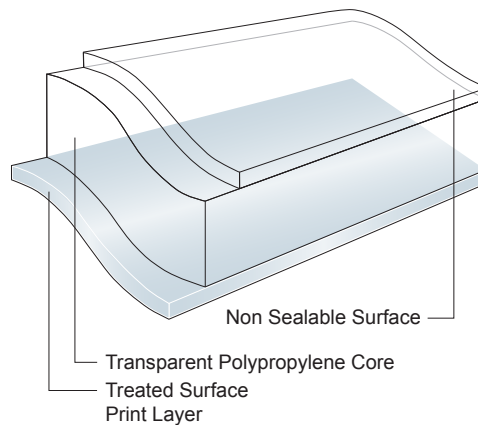

## MR103

2-side treated clear non heat sealable OPP film with improved heat stability to be considered for thermal processing applications (such as retorted or sterilized products). The 2-side treatment allows to bring more functionality e.g. applying a Matt lacquer. This film is designed for reverse printing as the outer web of a barrier laminate to help replace PET films and achieve mono-material PP-rich structures, for improved recyclability of flexible packaging either in existing or future PP or mixed PO recycling streams.

**Key Markets :** Wet pet food and Ready-to-(H)eat meals.

**Packaging Formats :** VFFS, HFFS, Stand-up Pouches, Flat Pouches, Flat Sachets, Pre-made Bags.

Thickness (µm)	Unit Weight (g/m <sup>2</sup> )	Gloss 20° (Release Layer)	CoF (Release Layer)
25	22,7	90	0,50

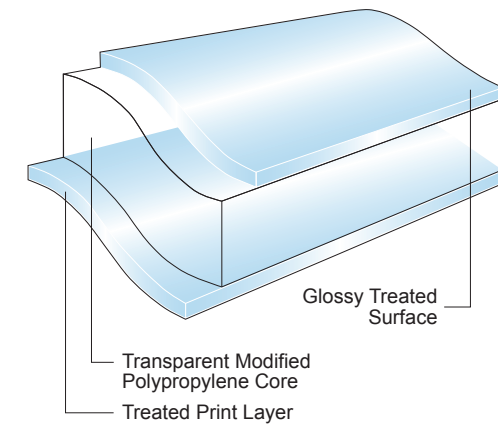

## MB344US

Transparent modified BOPP film with one side treated, one side Ultra Seal performance (18N/15mm) for use as the inside web of lamination for various packaging formats in replacement of CPP or PE films.

**Key Markets :** Biscuits, Baked Goods, Sweet & Chocolate Confectionery, Salty Snacks, Dried Fruits, Nuts, Crisps, Dry Pet Food.

**Packaging Formats :** HFFS, VFFS, Flat Sachets, Pouches, Pre-made Bags, Stand-up Pouches.

Thickness (µm)	Unit Weight (g/m <sup>2</sup> )	WVTR (g/m <sup>2</sup> /day)	CoF (non treated, sealing side)	Heat Seal Range (Seal Layer °C)
40	36,4	4,0	0,20	55*
50	45,5	4,0	0,20	55*

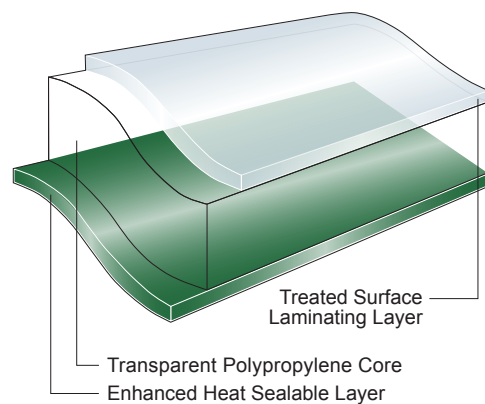

## MB666

Transparent BOPP film, acrylic coated on both sides, designed for broad range of applications in single web or laminates.

**Key Markets :** Biscuits, Baked Goods, Sweet Confectionery, Health & Beauty Aid, Home & Personal Care, Dry Pet Food.

**Packaging Formats :** HFFS, VFFS, OW, Flat Sachets, Pre-made Bags.

Thickness (µm)	Unit Weight (g/m <sup>2</sup> )	WVTR (g/m <sup>2</sup> /day)	Heat Seal Range (Acrylic °C)
20	18,2	7,0	55*
25	22,7	5,0	55*
31	28,2	4,5	55*
35	31,8	4,0	55*
41	37,3	3,5	55*

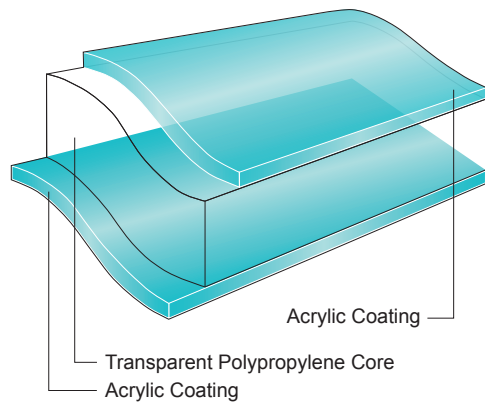

## MB600/MB621

Transparent BOPP film, acrylic coated on both sides, with outstanding optics for MB600, and low seal strength (peel) for MB621.

**Key Markets :** Biscuits, Baked Goods, Sweet Confectionery, Health & Beauty Aid, Home & Personal Care, Dry Pet Food, Tobacco (MB621), Tea (MB621).

**Packaging Formats :** HFFS, OW, Flat Sachets (MB600), Pre-made Bags.

### MB600

Thickness (µm)	Unit Weight (g/m <sup>2</sup> )	WVTR (g/m <sup>2</sup> /day)	Heat Seal Range (Acrylic °C)
26	23,7	5,0	55*
32	29,1	4,2	55*

### MB621

Thickness (µm)	Unit Weight (g/m <sup>2</sup> )	WVTR (g/m <sup>2</sup> /day)	Heat Seal Range (Acrylic °C)
21	19,1	7,0	55*

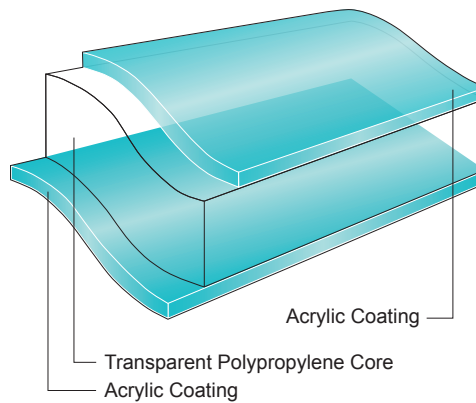

## MB602

Transparent BOPP film, coated one sided Acrylic, treated one side. Designed for use in lamination with itself or with another coated film, offering excellent machinability and lap seal performance. The film is aimed to help meet monomaterial requirements of the final laminate.

**Key Markets :** Biscuits, Baked Goods, Sweet Confectionery, Cereal Bars.

**Packaging Formats :** HFFS, VFFS, OW.

Thickness (µm)	Unit Weight (g/m <sup>2</sup> )	WVTR (g/m <sup>2</sup> /day)	Heat Seal Range (Acrylic °C)
19	17,2	7,0	55*

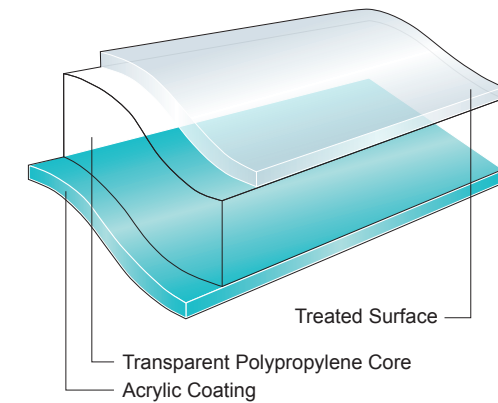

## ICT

Transparent BOPP film one side sealable, very broad seal range, designed for use in unsupported plain or surface printed high speed horizontal applications, with stable surface properties on the printable side.

**Key Markets :** Biscuits, Baked Goods, Sweet Confectionery, Ice Cream, Household Products, Detergents.

**Packaging Formats :** HFFS.

Thickness (µm)	Unit Weight (g/m <sup>2</sup> )	WVTR (g/m <sup>2</sup> /day)	CoF (Treated side)	Heat Seal Range (BSR °C)
25	22,2	5,0	0,28	65*
30	26,8	4,5	0,28	65*

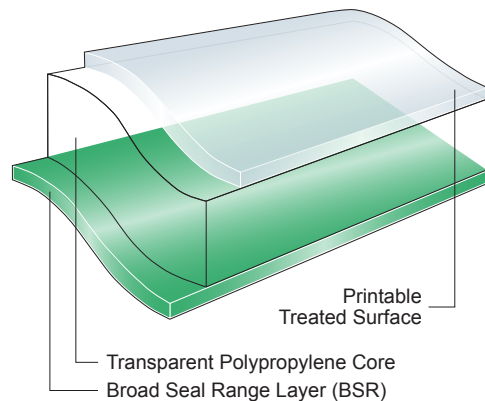

## CLH

Transparent BOPP film, Acrylic coated on both sides, designed for holographic applications. Also suitable for lamination with paper and cardboard.

**Key Markets :** Board lamination, Holographic applications.

**Packaging Formats :** HFFS, VFFS, OW, Rigid Packaging.

Thickness (µm)	Unit Weight (g/m <sup>2</sup> )	WVTR (g/m <sup>2</sup> /day)	Heat Seal Range (Acrylic °C)
20	18,3	6,8	55*
40	37,6	3,5	55*
50	47,4	3,0	55*

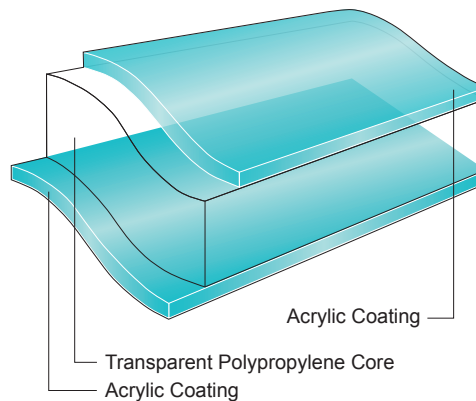

## COS5

Transparent biaxially oriented polypropylene film, coated on one side with a high gloss scuff resistant (SR) sealable polymer and other side with a low seal threshold polymer. This OPP film is water based coated especially developed for cosmetic or perfume box overwrap (OW) applications. It provides an excellent balance of properties in terms of optics, stiffness, scratch and perfume spray resistance with stable slip properties and outstanding low pressure seal performance, ideal for OW machines in premium applications.

**Key Markets :** Health & Beauty Aid, Home & Personal Care.

**Packaging Formats :** OW.

Thickness (µm)	Unit Weight (g/m <sup>2</sup> )	Gloss 45°C (SR)	Heat Seal Range (SR;Low SIT)
36	32,4	130	55 / 60
42	37,9	130	55 / 60

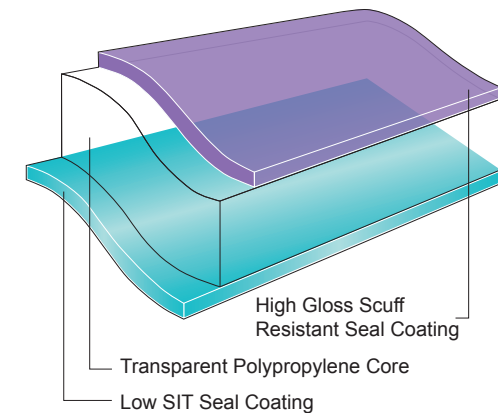



## MB777

Transparent BOPP film, coated one side PVdC, one side acrylic, designed for broad range of applications in single web or laminates.

**Key Markets :** Biscuits, Baked Goods, Sweet Confectionery, Salty Snacks, Nuts, Cereals, Health & Beauty Aid, Home & Personal Care, Dry Pet Food, Tea.

**Packaging Formats :** HFFS, VFFS, OW, Flat Sachets, Pre-made Bags.

Thickness (µm)	Unit Weight (g/m <sup>2</sup> )	WVTR (g/m <sup>2</sup> /day)	Heat Seal Range (Acrylic;PVdC °C)
21	20,4	5,0	55 / 50*
26	25,0	4,2	55 / 50*
32	30,4	3,8	55 / 50*
42	39,5	2,9	55 / 50*

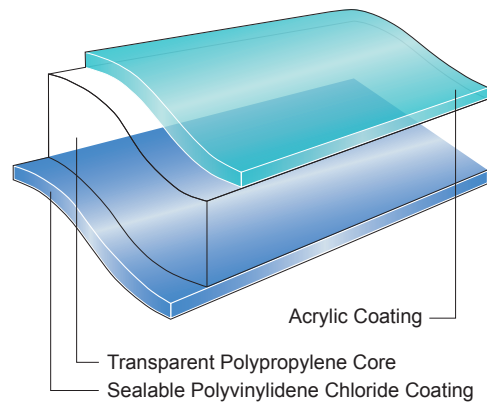

## COS

Transparent BOPP film, coated one side acrylic, one side PVdC, providing outstanding optics, scratch and alcohol resistance on the PVdC layer side and improved sealing performance. Primarily used for cosmetics.

**Key Markets :** Health & Beauty Aid, Home & Personal Care.

**Packaging Formats :** HFFS, VFFS, OW, Flat Sachets, Pre-made Bags.

Thickness (µm)	Unit Weight (g/m <sup>2</sup> )	Gloss 45°C (PVdC)	Heat Seal Range (Acrylic;PVdC °C)
32	29,4	98	55 / 50*
42	38,6	98	55 / 50*

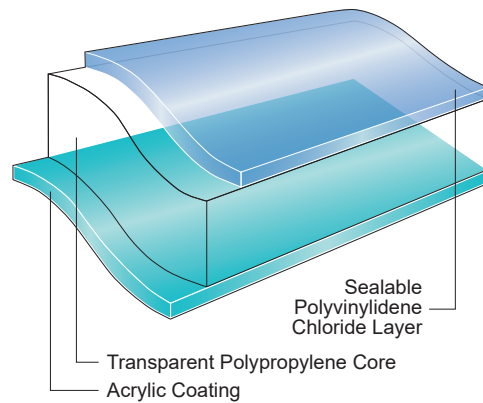

## MBX768

Transparent BOPP film, coated one side high barrier PVdC, one side very low temperature seal (VLTS).

**Key Markets :** Biscuits, Baked Goods, Sweet Confectionery, Salty Snacks, Cereal Bars, Health & Beauty Aid, Home & Personal Care, Pet Treats.

**Packaging Formats :** HFFS.

Thickness (µm)	Unit Weight (g/m <sup>2</sup> )	Gloss 45°C (g/m <sup>2</sup> /day)	Heat Seal Range (VLTS °C)
26	24,0	3,0	75*
32	29,4	3,0	75*

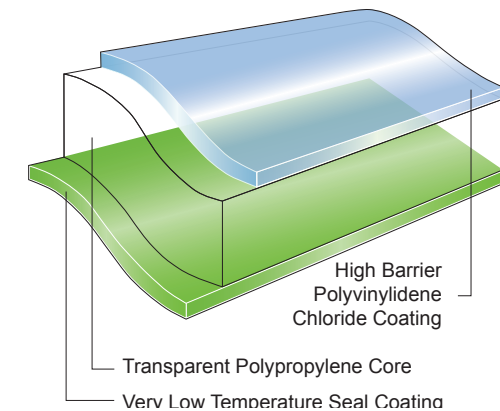

## MB668

Transparent BOPP film coated one side acrylic, one side very low temperature seal (VLTS), for outstanding seal performance.

**Key Markets :** Biscuits, Baked Goods, Sweet Confectionery, Health & Beauty Aid, Home & Personal Care.

**Packaging Formats :** HFFS, OW.

Thickness (µm)	Unit Weight (g/m <sup>2</sup> )	WVTR (g/m <sup>2</sup> /day)	Heat Seal Range (VLTS °C)
20	18,1	7,0	80*
25	22,6	5,0	80*
31	28,1	4,5	80*

## MBH668

Transparent BOPP film with improved moisture barrier, coated one side Acrylic and one side very low temperature seal (VLTS), for outstanding performance on high speed HFFS machine.

**Key Markets :** Biscuits, Baked Goods, Sweet Confectionery, Chocolate, Frozen Food, Cereal Bars, Health & Beauty Aid, Home & Personal Care, Household Products, Detergents, Dry Pet Food.

**Packaging Formats :** HFFS.

Thickness (µm)	Unit Weight (g/m <sup>2</sup> )	WVTR (g/m <sup>2</sup> /day)	Heat Seal Range (VLTS °C)
27	24,4	2,8	75*

## MBH568

Transparent biaxially oriented polypropylene film with improved barrier to moisture and gases, coated on one side with a modified printable barrier coating, one side with a very low seal temperature (VLTS) coating. For outstanding performance on high speed HFFS machines.

**Key Markets :** Biscuits, Baked Goods, Sweet Confectionery, Cereal Bars, Household Products, Detergents, Dry Pet Food.

**Packaging Formats :** HFFS.

Thickness (µm)	Unit Weight (g/m <sup>2</sup> )	WVTR (g/m <sup>2</sup> /day)	Heat Seal Range (VLTS °C)
25	22	3,1	75*
30	27,5	2,7	75*

Density (g/cm<sup>3</sup>) : 0.62

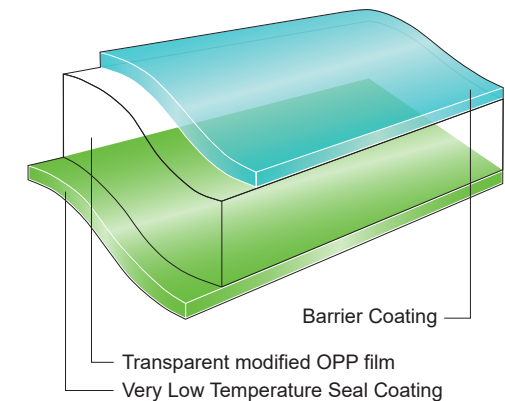
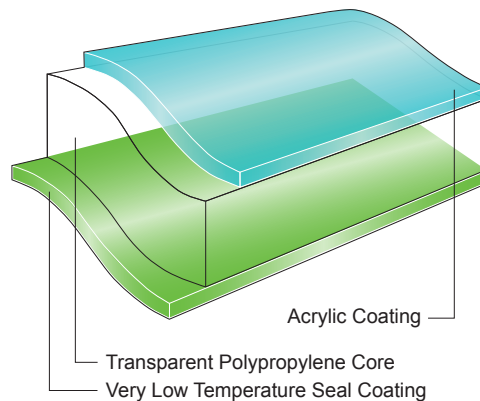
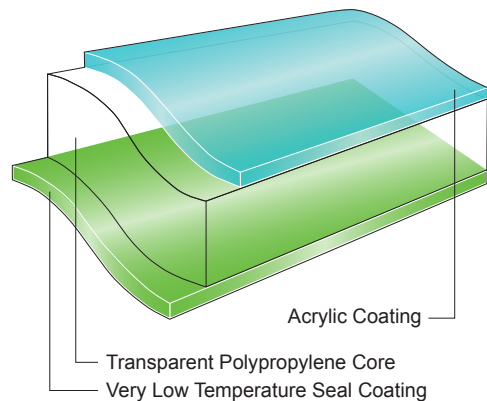

## MB866

Transparent BOPP film, coated one side acrylic, one side PVOH, designed to be used as the outer web in modified atmosphere packaging applications (MAP) for dry products.

**Key Markets :** Salty Snacks, Nuts, Cereals, Cereal Bars, Health & Beauty Aid, Home & Personal Care, Dry Pet Food.

**Packaging Formats :** HFFS, VFFS, Pre-made Bags.

Thickness (µm)	Unit Weight (g/m <sup>2</sup> )	O <sub>2</sub> TR (cc/m <sup>2</sup> /day)	Heat Seal Range (Acrylic °C)
20	18,0	0,5	55*

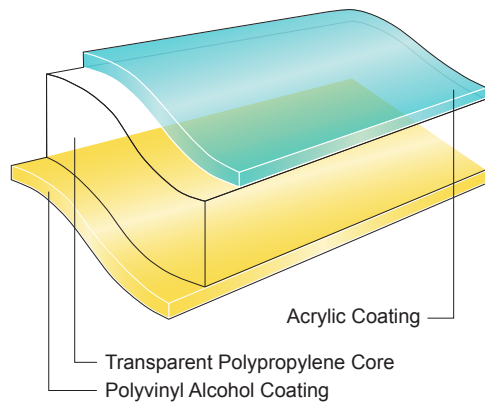

## MB890

High gas barrier, transparent BOPP film, coated one side with EVOH. It provides excellent gas and aroma protection and is designed to be used as the outer web in modified atmosphere packaging applications (MAP) for dry products. Lap sealable to PP film.

**Key Markets :** Cereal Bars, Salty Snacks, Crisps, Dried Fruits, Nuts, Household Products, Detergents, Dry Pet Food.

**Packaging Formats :** HFFS, VFFS, Pre-made Bags.

Thickness (µm)	Unit Weight (g/m <sup>2</sup> )	O <sub>2</sub> TR (cc/m <sup>2</sup> /day)	Heat Seal Range (Seal Layer °C)
16	14,1	0,5	40*

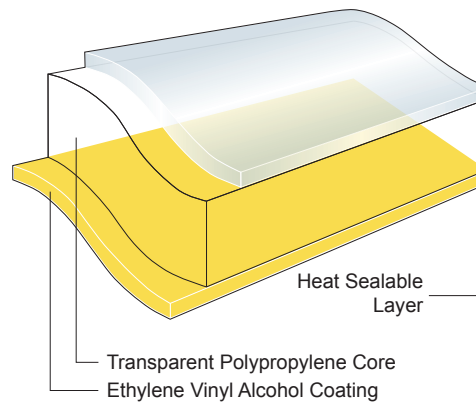

## SHD/SHH

White voided BOPP film with exceptional surface gloss. One side treated for SHD, two side treated for SHH. For cold seal applications and use in laminates.

**Key Markets :** Biscuits, Baked Goods, Chocolate Confectionery, Ice Cream, Salty Snacks, Cereal Bars.

**Packaging Formats :** HFFS.

Thickness (μm)	Unit Weight (g/m <sup>2</sup> )	WVTR (g/m <sup>2</sup> /day)
28 <sup>(1)</sup>	21,5	5,5
35	26,0	4,5
40 <sup>(1)</sup>	30,0	4,0
50	37,0	3,0
60	45,0	2,5

Density (g/cm<sup>3</sup>) : 0.75

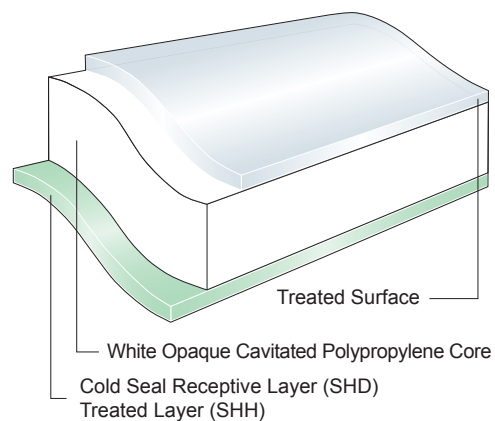

## MH247

Super White Opaque, modified higher density BOPP film, ideal for mono-web requirements. Especially designed for cold seal applications.

**Key Markets :** Biscuits, Baked Goods, Sweet Confectionery Chocolate, Ice Cream, Cereal Bars.

**Packaging Formats :** HFFS.

Thickness (μm)	Unit Weight (g/m <sup>2</sup> )	WVTR (g/m <sup>2</sup> /day)
35	25,4	4,9
40	29,0	4,2
50	36,3	3,0

Density (g/cm<sup>3</sup>) : 0.73

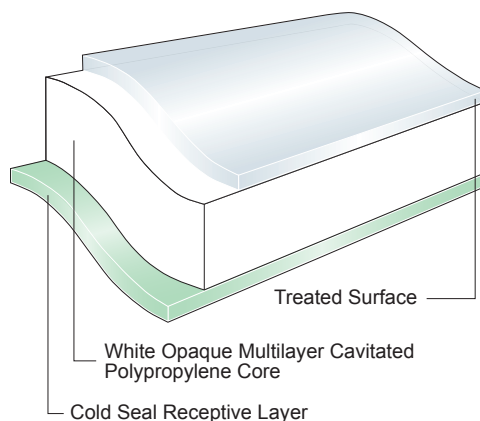

## MW247

Super white opaque BOPP film, designed for use in cold seal applications where superior optics and graphics are desired.

**Key Markets :** Biscuits, Baked Goods, Sweet Confectionery Chocolate, Ice Cream, Cereal Bars.

**Packaging Formats :** HFFS, OW.

Thickness (μm)	Unit Weight (g/m <sup>2</sup> )	WVTR (g/m <sup>2</sup> /day)
33	20,5	6,1
38	23,6	5,2
47	29,0	4,1

Density (g/cm<sup>3</sup>) : 0.62

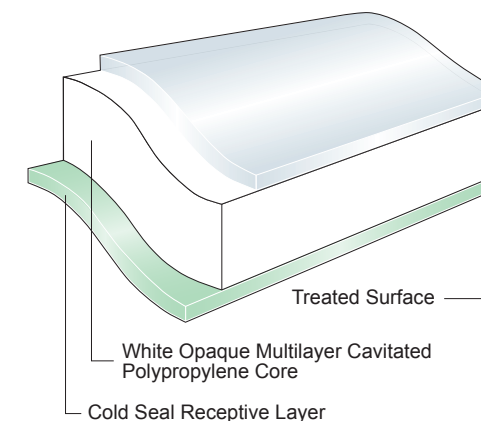

(1) SHH is only available in 28μ and 40μ.

## ICE

White opaque, modified low density BOPP film. Suitable for cold seal (on HFFS) and heat seal.

**Key Markets :** Ice Cream.

**Packaging Formats :** HFFS.

## D0447

White opaque BOPP film. Modified very low density and very high yield. Suitable for heat and cold seal.

**Key Markets :** Biscuits, Baked Goods, Chocolate Confectionery, Ice Cream, Salty Snacks, Nuts, Cereals.

**Packaging Formats :** HFFS, OW.

Thickness (µm)	Unit Weight (g/m <sup>2</sup> )	Heat Seal Range (Untreated °C)
33	20,5	45*
38	23,6	45*

Thickness (µm)	Unit Weight (g/m <sup>2</sup> )	Heat Seal Range (Untreated °C)
38	20,5	45*

Density (g/cm<sup>3</sup>) : 0.62

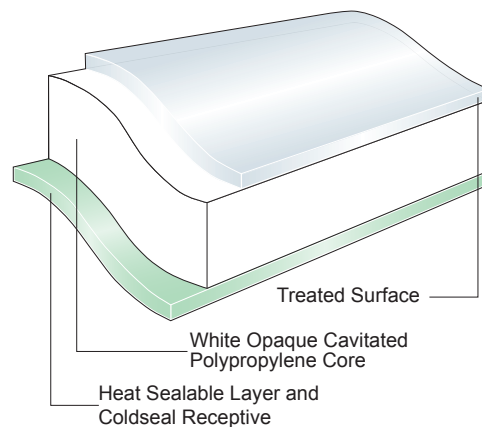

Density (g/cm<sup>3</sup>) : 0.54

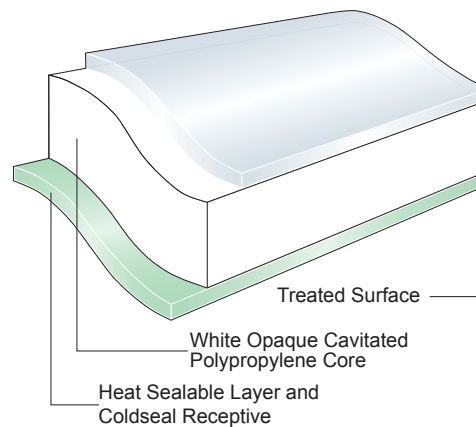

## HGP

White voided OPP film with high opacity and whiteness.

**Key Markets :** Biscuits, Baked Goods, Sweet Confectionery.

**Packaging Formats :** HFFS, VFFS.

## MD447

Super white opaque, modified higher density BOPP slip formulated coextruded film. Heat sealable on both sides with one side treated for general purpose applications on all pack formats.

**Key Markets :** Biscuits, Baked Goods, Chocolate Confectionery, Ice Cream, Salty Snacks.

**Packaging Formats :** HFFS, VFFS, OW, Pre-made Bags.

## WTD

Solid white coextruded BOPP film with high whiteness. Both sides sealable with one side treated. Suitable as a monoweb for laminates in heat and cold seal applications.

**Key Markets :** Biscuits, Baked Goods, Chocolate Confectionery, Ice Cream, Salty Snacks.

**Packaging Formats :** HFFS, VFFS, OW.

Thickness (µm)	Unit Weight (g/m <sup>2</sup> )	WVTR (g/m <sup>2</sup> /day)	Heat Seal Range (Untreated °C)
40	28,8	6,5	30**

Thickness (µm)	Unit Weight (g/m <sup>2</sup> )	WVTR (g/m <sup>2</sup> /day)	Heat Seal Range (Seal;Treated °C)
30	24,0	5,0	45 / 35*
35	27,9	4,5	45 / 35*

Thickness (µm)	Unit Weight (g/m <sup>2</sup> )	WVTR (g/m <sup>2</sup> /day)	Heat Seal Range (Untreated °C)
20	19,2	8,3	65*
25	24,0	6,6	65*
30	28,8	5,5	65*
35	33,6	4,7	65*
40	38,4	4,1	65*

Density (g/cm<sup>3</sup>) : 0.72

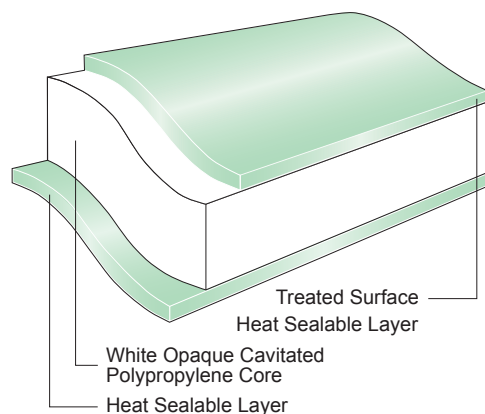

Density (g/cm<sup>3</sup>) : 0.80

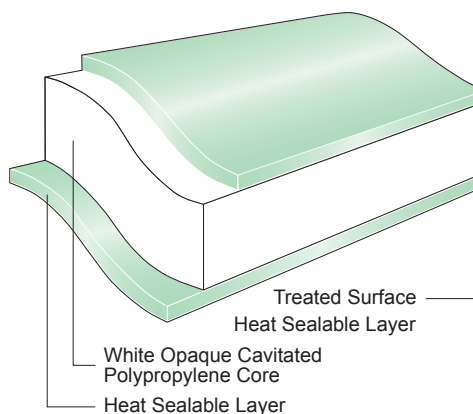

Density (g/cm<sup>3</sup>) : 0.96

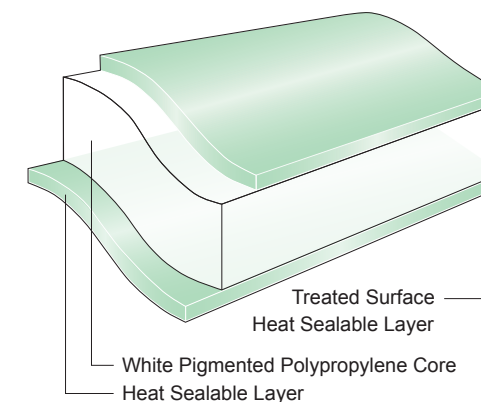

## STD

High gloss white voided OPP film with a very low sealing threshold (80°C) designed for heat seal applications. Ultra wide sealing range for high speed HFFS packaging machines. Suitable as a monoweb or in laminates.

**Key Markets :** Biscuits, Baked Goods, Sweet Confectionery, Chocolate, Ice Cream.

**Packaging Formats :** HFFS.

Thickness (µm)	Unit Weight (g/m <sup>2</sup> )	WVTR (g/m <sup>2</sup> /day)	Heat Seal Range (Untreated °C)
28	21,5	5,5	60**
35	26,0	4,5	60**
40	30,0	4,0	60**
50	37,0	3,0	60**

**Density (g/cm<sup>3</sup>) :** 0.75

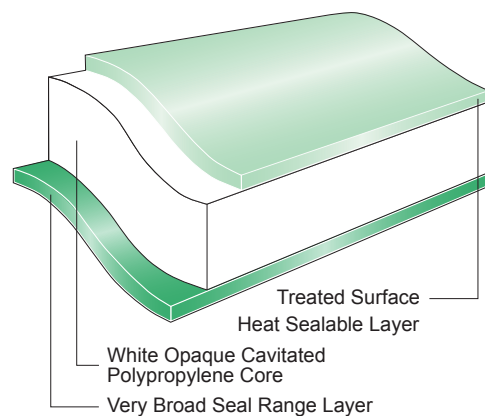

## VLD

High gloss white voided BOPP film with a very low sealing threshold (80°C) designed for heat seal applications.

**Key Markets :** Biscuits, Baked Goods, Sweet Confectionery, Chocolate & Ice Cream.

**Packaging Formats :** HFFS.

Thickness (µm)	Unit Weight (g/m <sup>2</sup> )	WVTR (g/m <sup>2</sup> /day)	Heat Seal Range (Untreated °C)
40	23.5	5.5	60**

**Density (g/cm<sup>3</sup>) :** 0.62

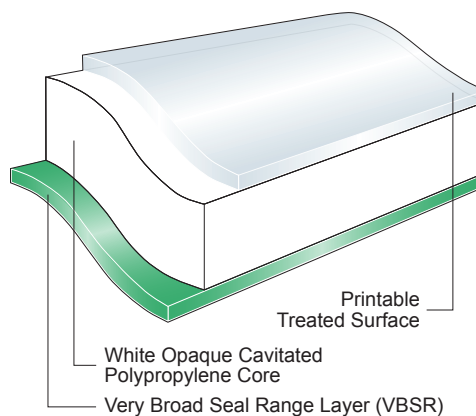

## SVD

High gloss white voided BOPP film with a low threshold sealing layer (100°C) designed for VFFS applications, suitable for laminates. The film has a modified intermediate layer that promotes easy opening (peelable).

**Key Markets :** Biscuits, Baked Goods, Sweet Confectionery, Salty Snacks.

**Packaging Formats :** HFFS, VFFS.

Thickness (µm)	Unit Weight (g/m <sup>2</sup> )	WVTR (g/m <sup>2</sup> /day)	Heat Seal Range (Untreated °C)
28	21,0	4,8	40**

**Density (g/cm<sup>3</sup>) :** 0.75

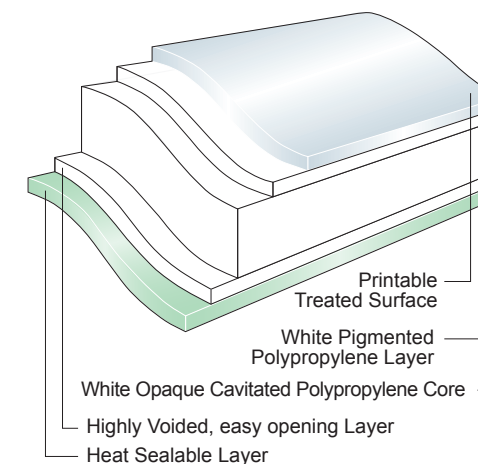

## MW647

Super white opaque BOPP film, acrylic coated on both sides, providing good aroma barrier. Designed for a broad range of applications in single web or laminates.

**Key Markets :** Biscuits, Baked Goods, Sweet Confectionery, Salty Snacks, Tea.

**Packaging Formats :** HFFS, OW, Flat Sachets.

## MH647

Super white opaque BOPP film, modified higher density, acrylic coated on both sides, providing good aroma barrier.

**Key Markets :** Biscuits, Baked Goods, Sweet Confectionery, Salty Snacks, Tea.

**Packaging Formats :** HFFS, VFFS, OW, Flat Sachets, Pre-made Bags.

Thickness (μm)	Unit Weight (g/m <sup>2</sup> )	WVTR (g/m <sup>2</sup> /day)	Heat Seal Range (Acrylic °C)
35	22,5	6,1	55*
40	25,6	5,2	55*
45	28,7	4,1	55*

Thickness (μm)	Unit Weight (g/m <sup>2</sup> )	WVTR (g/m <sup>2</sup> /day)	Heat Seal Range (Acrylic °C)
42	31,1	4,0	55*

Density (g/cm<sup>3</sup>) : 0.64

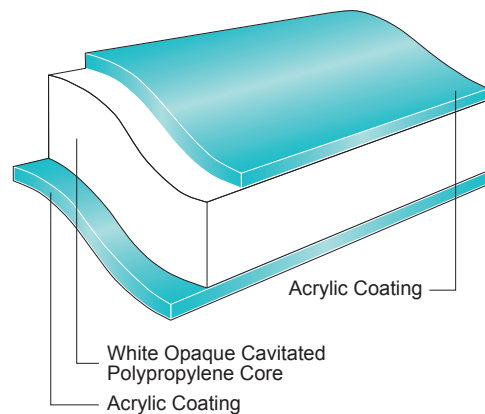

Density (g/cm<sup>3</sup>) : 0.74

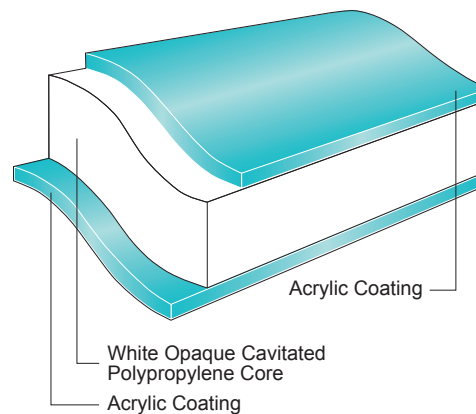



## M0747

Cavitated white opaque BOPP film, one side acrylic coated, one side PVdC coated. This film provides good moisture and aroma barrier.

**Key Markets :** Biscuits, Baked Goods, Sweet Confectionery, Salty Snacks, Nuts, Cereal Bars, Health & Beauty Aid, Tea, Home & Personal Care.

**Packaging Formats :** HFFS, OW, Flat Sachets.

Thickness (µm)	Unit Weight (g/m <sup>2</sup> )	WVTR (g/m <sup>2</sup> /day)	Heat Seal Range (Acrylic, PVdC, °C)
36	24,8	4,8	55 / 50*
50	33,4	3,4	55 / 50*

**Density (g/cm<sup>3</sup>) :** 36 µm 0.69; 50 µm 0.67

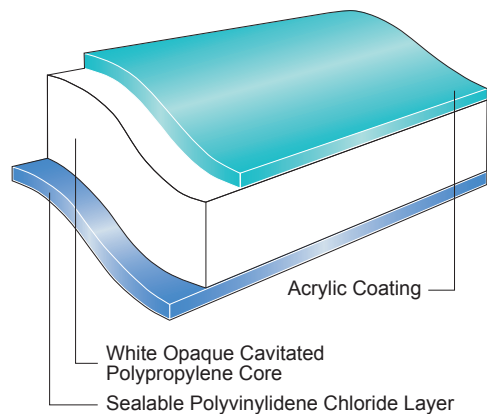

## MW747

Super white opaque BOPP film, one side acrylic coated, one side PVdC coated. This film provides good moisture and aroma barrier.

**Key Markets :** Biscuits, Baked Goods, Sweet Confectionery, Salty Snacks, Nuts, Cereals, Health & Beauty Aid, Home & Personal Care.

**Packaging Formats :** HFFS, OW, Flat Sachets.

Thickness (µm)	Unit Weight (g/m <sup>2</sup> )	WVTR (g/m <sup>2</sup> /day)	Heat Seal Range (Acrylic, PVdC, °C)
31	21,7	5,2	55 / 50*

**Density (g/cm<sup>3</sup>) :** 0.60

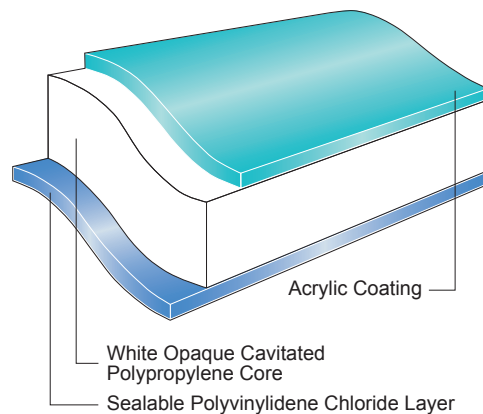

## MW648

Super white opaque BOPP film, one side acrylic coated, one side very low temperature seal (VLTS) coated.

**Key Markets :** Biscuits, Baked Goods, Sweet Confectionery, Cereal Bars, Health & Beauty Aid, Home & Personal Care, Pet Treats.

**Packaging Formats :** HFFS.

## MH648

Super white opaque BOPP film, modified higher density, one side acrylic coated, one side very low temperature seal (VLTS) coated.

**Key Markets :** Biscuits, Baked Goods, Sweet Confectionery, Cereal Bars, Health & Beauty Aid, Home & Personal Care, Pet Treats.

**Packaging Formats :** HFFS.

Thickness (µm)	Unit Weight (g/m <sup>2</sup> )	WVTR (g/m <sup>2</sup> /day)	Heat Seal Range (VLTS °C)
30	19,3	7,0	80*
40	25,5	5,2	80*

Thickness (µm)	Unit Weight (g/m <sup>2</sup> )	WVTR (g/m <sup>2</sup> /day)	Heat Seal Range (VLTS °C)
42	31,0	4,0	80*
52	38,5	3,0	80*

Density (g/cm<sup>3</sup>) : 0.64

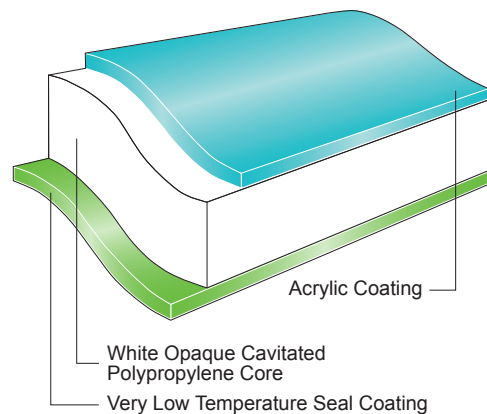

Density (g/cm<sup>3</sup>) : 0.74

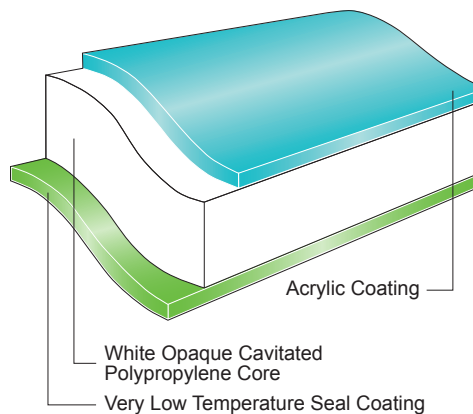

### MM480

Clear metallized BOPP film metallized one side, designed to be used in lamination with other substrates on HFFS and VFFS applications. When laminated with standard coex, it can be lap sealed.

**Key Markets :** Biscuits, Baked Goods, Sweet Confectionery, Salty Snacks.

**Packaging Formats :** HFFS, VFFS, OW.

### MM488

Clear metallized BOPP film metallized one side, designed to be used in laminates as the inner web for VFFS and HFFS applications with a CoF of 0.32 for 15µm and 0.40 for 18µm. When laminated with standard coex, it can be lap sealed.

**Key Markets :** Biscuits, Baked Goods, Sweet Confectionery, Salty Snacks, Cereals, Health & Beauty Aid, Home & Personal Care, Pet Treats.

**Packaging Formats :** HFFS, VFFS, OW, Flat Sachets, Pre-made Bags.

### MM280

Clear metallized BOPP film, metallized on one side, treated on the other side, used in lamination with other substrates on HFFS and VFFS applications.

**Key Markets :** Biscuits, Baked Goods, Sweet Confectionery, Salty Snacks, Health & Beauty Aid, Home & Personal Care, Dry Pet Food.

**Packaging Formats :** HFFS, VFFS.

Thickness (µm)	Unit Weight (g/m <sup>2</sup> )	WVTR (g/m <sup>2</sup> /day)	Heat Seal Range (°C)
15	13,7	0,8	40*
18	16,4	0,8	40*
20	18,2	0,8	40*
30	26,4	0,8	40*

Thickness (µm)	Unit Weight (g/m <sup>2</sup> )	WVTR (g/m <sup>2</sup> /day)	O <sub>2</sub> TR (cc/m <sup>2</sup> /day)	Heat Seal Range (°C)
12	10,9	0,3	50	40*
15	13,7	0,3	50	40*
18	16,4	0,3	50	40*

Thickness (µm)	Unit Weight (g/m <sup>2</sup> )	WVTR (g/m <sup>2</sup> /day)
30	26,4	0,8

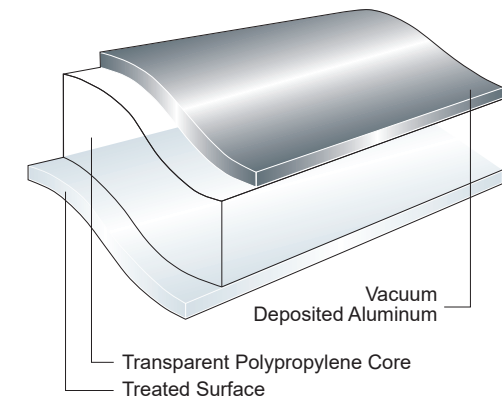
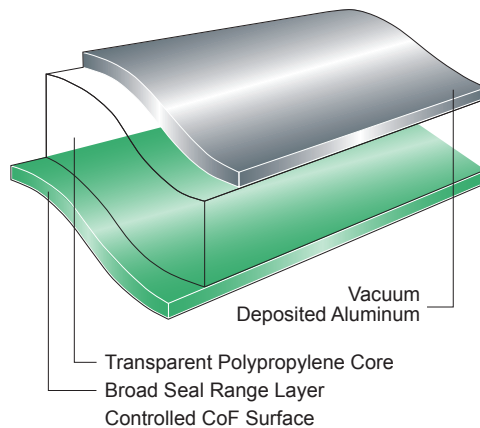
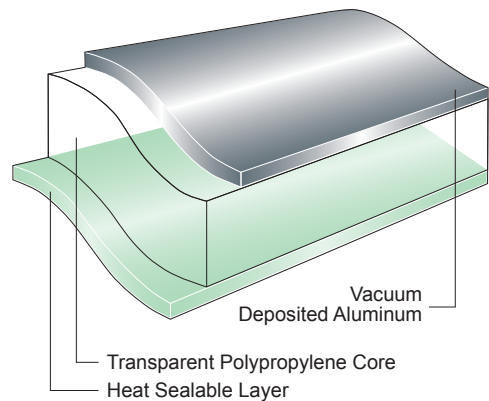

## MM388

Clear metallized BOPP film metallized one side, with a broad seal range surface on the other side, designed for high barrier performance packaging applications.

**Key Markets :** Health & Beauty Aid, Home & Personal Care, Dehydrated Food.

**Packaging Formats :** HFFS, VFFS.

## MM398

Clear metallized BOPP barrier film, with a very broad seal range, designed for very high speed HFFS applications where improved seal integrity is required.

**Key Markets :** Biscuits, Baked Goods, Sweet Confectionery, Cereal Bars, Health & Beauty Aid, Home & Personal Care, Pet Treats.

**Packaging Formats :** HFFS.

## MLB

Transparent, metallised BOPP film with medium barrier properties for light, moisture and gas. Designed for heat sealable applications and offers excellent performance on high speed packaging machines due to its low temperature sealing face.

**Key Markets :** Biscuits, Baked Goods, Sweet Confectionery, Cereal Bars, Health & Beauty Aid, Home & Personal Care, Pet Treats.

**Packaging Formats :** HFFS.

Thickness (µm)	Unit Weight (g/m <sup>2</sup> )	WVTR (g/m <sup>2</sup> /day)	O <sub>2</sub> TR (cc/m <sup>2</sup> /day)	Heat Seal Range (°C)
18	16,2	0,2	26	40*

Thickness (µm)	Unit Weight (g/m <sup>2</sup> )	WVTR (g/m <sup>2</sup> /day)	O <sub>2</sub> TR (cc/m <sup>2</sup> /day)	Heat Seal Range (°C)
15	13,7	0,3	50	65*

Thickness (µm)	Unit Weight (g/m <sup>2</sup> )	WVTR (g/m <sup>2</sup> /day)	O <sub>2</sub> TR (cc/m <sup>2</sup> /day)	Heat Seal Range (°C)
20	18,2	0,3	40	84*
30	27,3	0,3	40	84*

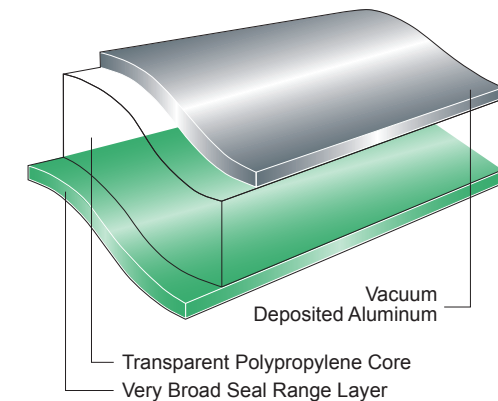
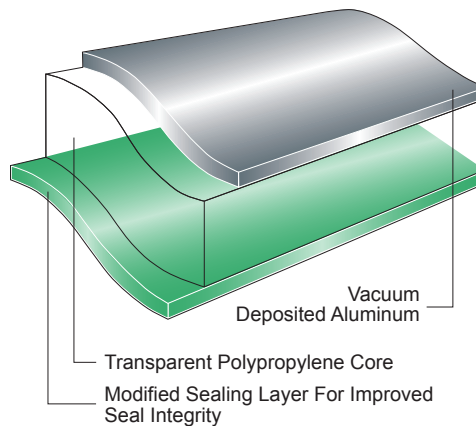
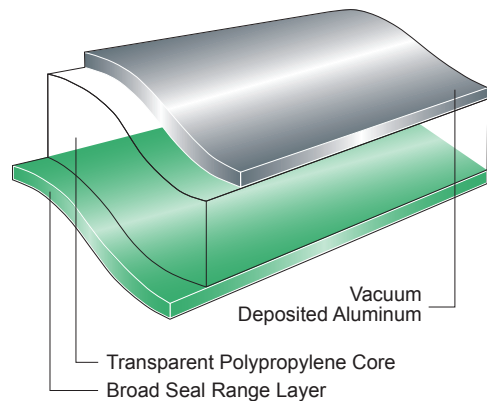

## MM288

Clear very high barrier metallized BOPP film, metallized on one side, treated on the other side, designed for use as the center web of a triplex lamination, or as the inner web of a cold seal lamination. The treated surface offers good compatibility with adhesives and cold seal laminations.

**Key Markets :** Biscuits, Baked Goods, Sweet Confectionery, Salty Snacks, Nuts, Cereals, Health & Beauty Aid, Home & Personal Care, Dry Pet Food, Dry Food, Beverage Powders.

**Packaging Formats :** HFFS, VFFS, Flat Sachets, Pouches, Stand-up Pouches.

Thickness (µm)	Unit Weight (g/m <sup>2</sup> )	Optical Density	WVTR (g/m <sup>2</sup> /day)	O <sub>2</sub> TR (cc/m <sup>2</sup> /day)
15	13,7	2,8	0,1	25

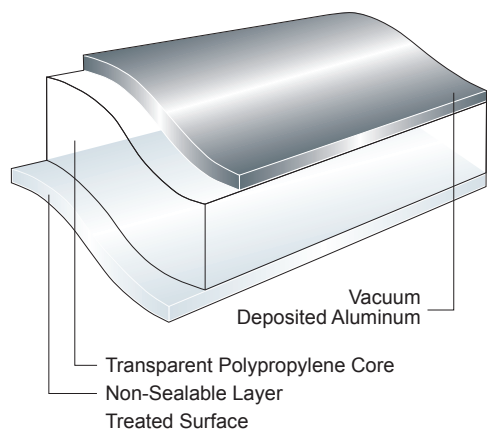

## MM883

Clear metallized ultra-high barrier (UHB) BOPP multilayer film, excellent barrier to light, oxygen, water vapor, aromas and mineral oils. The non metallized side is treated for adhesive lamination for use as the center web of a triplex lamination or for a cold seal application.

**Key Markets :** Biscuits, Baked Goods, Sweet Confectionery, Salty Snacks, Nuts, Cereals, Health & Beauty Aid, Home & Personal Care, Dry Pet Food, Dry Food, Beverage Powders, Coffee.

**Packaging Formats :** HFFS, VFFS, Flat Sachets, Pouches, Stand-up Pouches.

Thickness (µm)	Unit Weight (g/m <sup>2</sup> )	Optical Density	WVTR (g/m <sup>2</sup> /day)	O <sub>2</sub> TR (cc/m <sup>2</sup> /day)
16	14,1	2,8	0,1	0,1

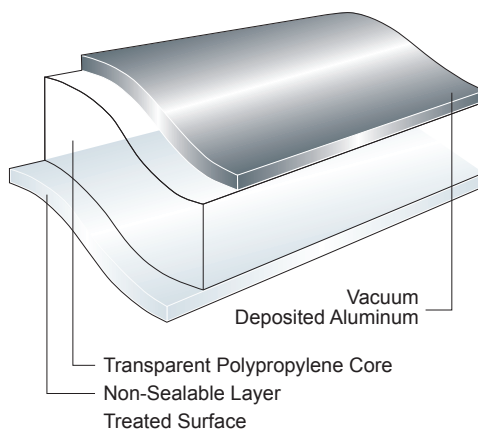

## MML883

Clear metallized ultra-high barrier (UHB) BOPP multilayer film. Excellent barrier to oxygen, flavors, aromas, mineral oils and an excellent water vapor barrier. The non-metallized side is treated for adhesive lamination. MML883 is designed to help provide better bond strength for some liquid packaging applications but excluding retort.

**Key Markets :** Dairy Products, Dry Foods, Beverage Powders, Health & Beauty Aid, Industrial, Pharmaceuticals, Condiments.

**Packaging Formats :** HFFS, VFFS. Flat Sachet, Pouches, Stand Up Pouches, Lidding, Pre-made Bags.

Thickness (µm)	Unit Weight (g/m <sup>2</sup> )	Optical Density	WVTR (g/m <sup>2</sup> /day)	O <sub>2</sub> TR (cc/m <sup>2</sup> /day)
18	16,4	2,8	0,1	0,1

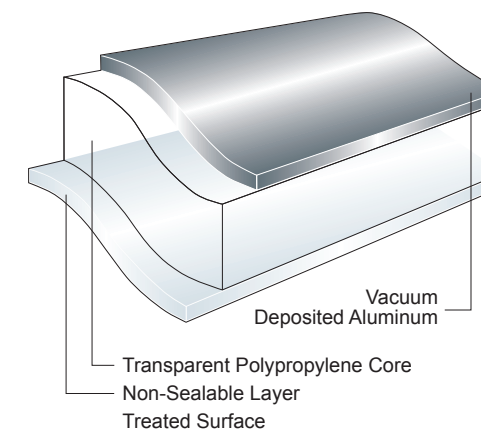

## ICE M

Super white opaque metallized BOPP film, metallized on one side, heat sealable or cold seal receptive on the other side.

**Key Markets :** Ice Cream.

**Packaging Formats :** HFFS.

## MW280

Super white opaque metallized BOPP film, metallized on one side, designed for single web applications on HFFS in combination with cold seal, or in heat seal applications.

**Key Markets :** Biscuits, Baked Goods, Sweet Confectionery, Soup or Stock Cubes.

**Packaging Formats :** HFFS, OW.

## MW480

Super white opaque metallized BOPP film, metallized on one side, heat sealable on the other side.

**Key Markets :** Biscuits, Baked Goods, Sweet Confectionery, Salty Snacks.

**Packaging Formats :** HFFS, OW.

Thickness (μm)	Unit Weight (g/m <sup>2</sup> )	Heat Seal Range (°C)
38	23,6	45*

Thickness (μm)	Unit Weight (g/m <sup>2</sup> )	WVTR (g/m <sup>2</sup> /day)
38	23,6	2,5

Thickness (μm)	Unit Weight (g/m <sup>2</sup> )	WVTR (g/m <sup>2</sup> /day)	O <sub>2</sub> TR (cc/m <sup>2</sup> /day)
38	23,6	0,5	80

Density (g/cm<sup>3</sup>) : 0.62

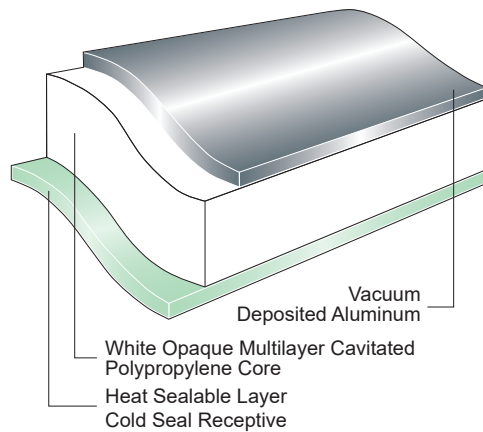

Density (g/cm<sup>3</sup>) : 0.62

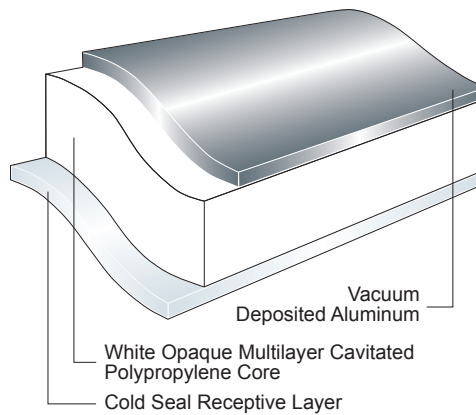

Density (g/cm<sup>3</sup>) : 0.62

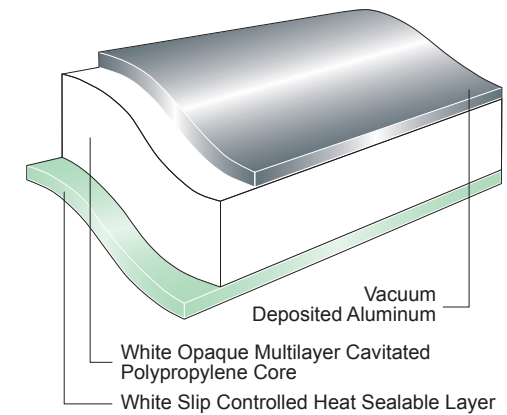

## MH0280

Super white opaque modified higher density BOPP film, metallized on one side treated on the other side, designed for use in applications as single web with cold seal or in lamination.

**Key Markets :** Biscuits, Baked Goods, Sweet Confectionery.

**Packaging Formats :** HFFS.

Thickness (μm)	Unit Weight (g/m <sup>2</sup> )	WVTR (g/m <sup>2</sup> /day)
35	25,4	0,1

Density (g/cm<sup>3</sup>) : 0.72

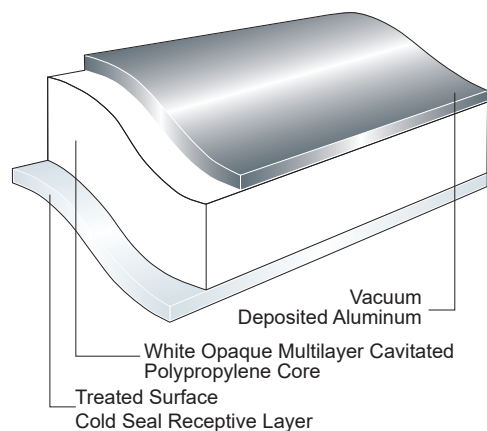

## High Barrier Metallized White Film

## MU842

White opaque ultra high barrier (UHB) metallized BOPP film, with aluminum deposited on an adhesion promoting layer. The proprietary core and a modified outer skin provide high opacity and a white background. Designed for use in laminations as well as in single web (with cold seal).

**Key Markets :** Biscuits, Baked Goods, Sweet Confectionery, Salty Snacks, Nuts, Cereals, Health & Beauty Aid, Home & Personal Care, Dry Pet Food, Dry Food, Beverage Powders.

**Packaging Formats :** HFFS, VFFS, Flat Sachets, Stand-up Pouches.

Thickness (μm)	Unit Weight (g/m <sup>2</sup> )	WVTR (g/m <sup>2</sup> /day)	O <sub>2</sub> TR (cc/m <sup>2</sup> /day)
28	20,7	0,1	0,1
35	25,2	0,1	0,1

Density (g/cm<sup>3</sup>) : 0.72

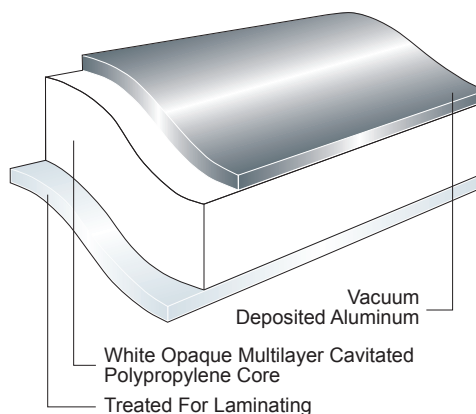

## QFM

High gloss, voided metallized white BOPP film with medium barrier properties. Specially designed for high speed horizontal packaging applications where medium barrier properties are required. Tailored to produce a higher yield film than standard, to provide an improved balance of yield and physical properties.

**Key Markets :** Biscuits, Baked Goods, Chocolate Confectionery, Ice Cream.

**Packaging Formats :** HFFS.

Thickness (µm)	Unit Weight (g/m <sup>2</sup> )	WVTR (g/m <sup>2</sup> /day)	O <sub>2</sub> TR (cc/m <sup>2</sup> /day)	Heat Seal Range (°C)
35	23,5	0,2	30	55**

Density (g/cm<sup>3</sup>) : 0.70

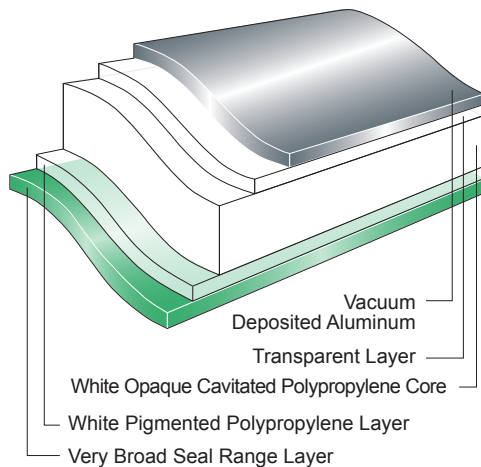

## UBWES

Super white opaque ultra high barrier (UHB) metallized BOPP film, metallized on one side with a proprietary sealant layer on the other. Enhanced Sealant technology provides high seal strength and better seal integrity. Lap sealable to other coextruded BOPP films. Used as the inner web.

**Key Markets :** Biscuits, Baked Goods, Sweet Confectionery, Salty Snacks, Health & Beauty Aid, Home & Personal Care, Dry Pet Food, Dry Food, Beverage Powders.

**Packaging Formats :** HFFS, VFFS, Flat Sachets, Pouches, Stand-up Pouches.

Thickness (µm)	Unit Weight (g/m <sup>2</sup> )	WVTR (g/m <sup>2</sup> /day)	O <sub>2</sub> TR (cc/m <sup>2</sup> /day)	Heat Seal Range (°C)
28	20,7	0,1	0,1	65*

Density (g/cm<sup>3</sup>) : 0.74

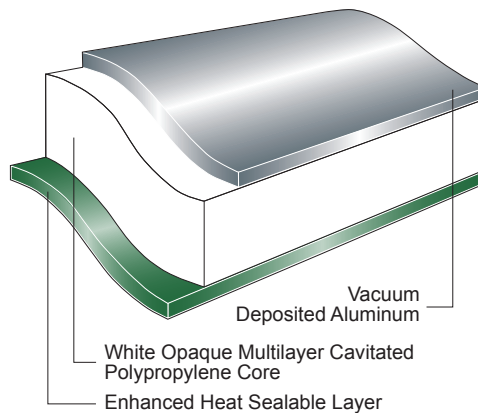



## A0893

High barrier, transparent BOPP film, vacuum coated on one side with Aluminum Oxide and corona treated on the other side, designed to be used as the middle web of barrier laminates.

**Key Markets :** Biscuits, Baked Goods, Health & Beauty Aid, Crisps, Salty Snacks, Nuts, Dry Food, Beverage Powders, Dry Pet Food.

**Packaging Formats :** HFFS, VFFS, Flat Sachets, Pouches, Stand-up Pouches.

Thickness (μm)	Unit Weight (g/m <sup>2</sup> )	WVTR (g/m <sup>2</sup> /day)	O <sub>2</sub> TR (cc/m <sup>2</sup> /day)
16	14,1	0,7	0,5

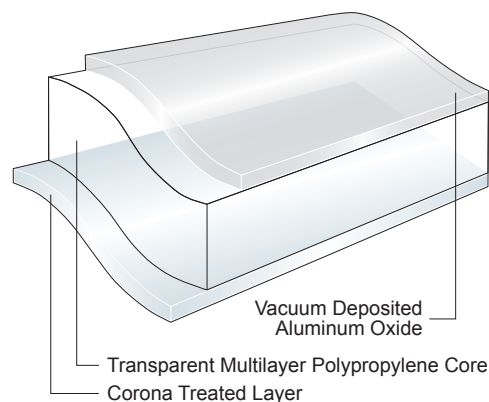

## A0894

High barrier, transparent BOPP film, vacuum coated on one side with Aluminum Oxide and heat sealable on the other side, designed to be used as the inner web for barrier laminates.

**Key Markets :** Biscuits, Baked Goods, Health & Beauty Aid, Crisps, Salty Snacks, Dry Food, Pet Treats.

**Packaging Formats :** HFFS, VFFS, Flat Sachets.

Thickness (μm)	Unit Weight (g/m <sup>2</sup> )	WVTR (g/m <sup>2</sup> /day)	O <sub>2</sub> TR (cc/m <sup>2</sup> /day)	Heat Seal Range (°C)
16	14,1	0,7	0,5	40*

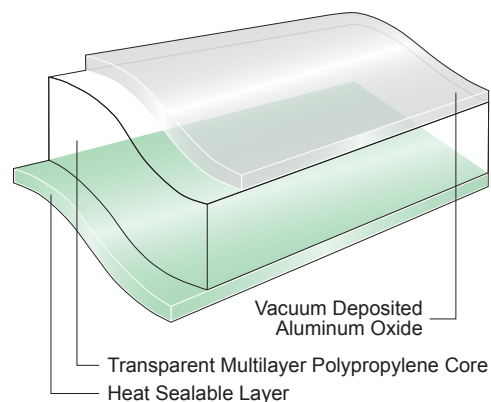

## A0L893

High barrier, transparent BOPP film, vacuum coated on one side with Aluminum Oxide and treated for adhesive lamination on the other side. Designed to be used for Heat Process applications up to 95°C such as Pasteurization.

**Key Markets :** Baby Food, Dairy Products, Condiments, Meat, Sauces, Cheese.

**Packaging Formats :** HFFS, VFFS, Flat Sachets, Pouches, Stand Up Pouches, Pre-made Bags.

Thickness (μm)	Unit Weight (g/m <sup>2</sup> )	WVTR (g/m <sup>2</sup> /day)	O <sub>2</sub> TR (cc/m <sup>2</sup> /day)
18	16,4	1,5	1,5

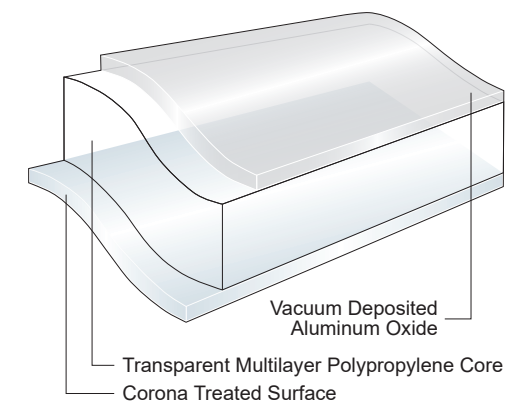

## XE400

Transparent, biaxially oriented polyethylene (BOPE) film. High performance sealing film with good mechanical properties and high puncture resistance. Designed for printing and laminating, to be used as single web or within laminates. For fully recyclable mono-PE packaging solutions.

**Key Markets :** Biscuits, Sweet Confectionery, Crisps, Salty Snacks, Nuts, Baked Goods, Dairy Products, Fresh Food, Frozen Food, Dry Pet Food, Health & Beauty Aid, Detergents, other Nonfood.

**Packaging Formats :** HFFS, VFFS, Pre-made Bags, Stand-up Pouches.

Thickness (µm)	Unit Weight (g/m <sup>2</sup> )	WVTR (g/m <sup>2</sup> /day)	Seal Strength (g/25mm)
18	16,7	24	5000
23	21,3	18	5000

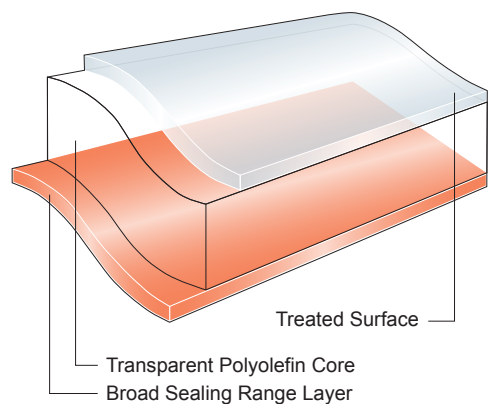

## HD200

Transparent, bi-axially oriented polyethylene (HDPE) film. High performance printing web with good mechanical properties and best heat resistance. Designed for high speed printing (rotogravure, flexo) and laminating with PE sealant films, like SealTOUGH™ or blown PE films. Wide operating windows in heat seal packaging processes. For fully recyclable mono-PE packaging solutions.

**Key Markets :** Biscuits, Sweet Confectionery, Baked Goods, Salty Snacks, Nuts, Dried Fruits, Dairy Products, Fresh Food, Frozen Food, Dry Pet Food, Health & Beauty Aid, Household Products, Detergents, other Nonfood.

**Packaging Formats :** HFFS, VFFS, Pre-made Bags, Stand-up Pouches.

Thickness (µm)	Unit Weight (g/m <sup>2</sup> )	WVTR (g/m <sup>2</sup> /day)	CoF (Untreated)
20	19,00	6,0	0,35
25	23,75	5,0	0,35

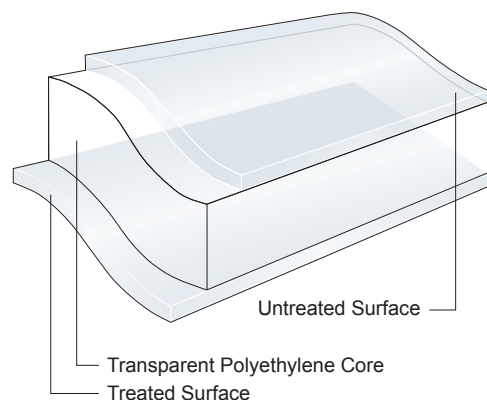

## HD240

One side sealable, bi-axially oriented polyethylene (HDPE) film. High performance printing web with good mechanical properties. Designed for high speed printing (rotogravure, flexo) and laminating with PE sealant films. HD240 can be used for lap seal, gusset or bottom sealing, but also for single web sealant applications. Wide operating windows in heat seal packaging processes. For fully recyclable mono-PE packaging solutions.

**Key Markets :** Biscuits, Sweet Confectionery, Baked Goods, Salty Snacks, Nuts, Dried Fruits, Dairy Products, Fresh Food, Frozen Food, Dry Pet Food, Health & Beauty Aid, Household Products, Detergents, other Nonfood.

**Packaging Formats :** HFFS, VFFS, Pre-made Bags, Stand-up Pouches.

Thickness (µm)	Unit Weight (g/m <sup>2</sup> )	WVTR (g/m <sup>2</sup> /day)	CoF (Untreated)
25	23,75	5,0	0,35
35	33,25	5,0	0,30

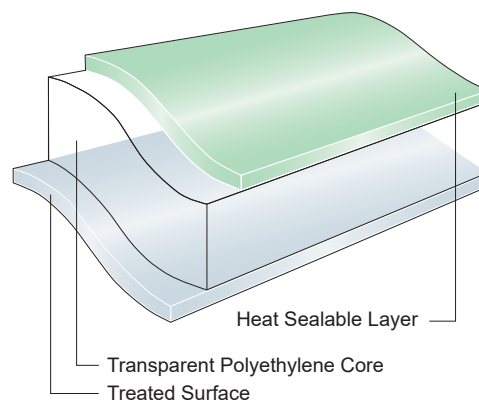

## HD235

Matt finish, sealable, bi-axially oriented polyethylene (HDPE) film. High performance printing web with good mechanical properties. Designed for high speed printing (rotogravure, flexo) and laminating with PE sealant films. HD235 can be used for lap seal, gusset or bottom sealing. Wide operating windows in heat seal packaging processes. For fully recyclable mono-PE packaging solutions.

**Key Markets :** Biscuits, Baked Goods, Crisps, Salty Snacks, Fresh Food, Frozen Food, Dry Pet Food, Health & Beauty Aid, Household Products, Detergents.

**Packaging Formats :** HFFS, VFFS, Pouches, Pre-made Bags, Stand-up Pouches.

Thickness (µm)	Unit Weight (g/m <sup>2</sup> )	WVTR (g/m <sup>2</sup> /day)	CoF (Untreated vs metal)
25	22,70	5,0	0,40

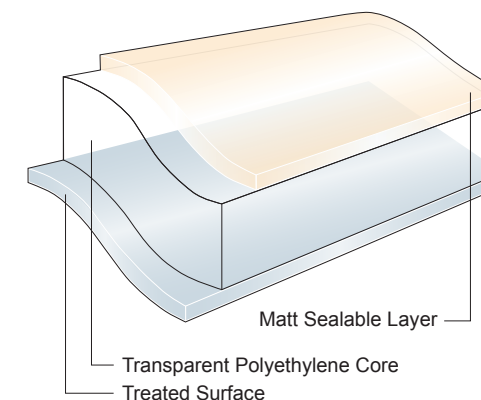

## HD213

Two-sides treated, bi-axially oriented, high density polyethylene (HDPE) film. Designed as a high performance printing & lamination web. Lamination of 25HD213 as outer web for two-sides printing, inner side is designed to be reverse printed and laminated while the outer side is treated to receive over lacquer like matte varnish or thermal resistant lacquer or inner web for cold seal applications.

**Key Markets :** Biscuits, Sweet Confectionery, Baked Goods, Salty Snacks, Nuts, Dried Fruits, Fresh Food, Frozen Food, Dry Pet Food, Health & Beauty Aid, Household Products, Detergents, other Nonfood.

**Packaging Formats :** HFFS, VFFS, Pre-made Bags, Stand-up Pouches.

Thickness ( $\mu\text{m}$ )	Unit Weight ( $\text{g}/\text{m}^2$ )	WVTR ( $\text{g}/\text{m}^2/\text{day}$ )
25	23,10	5,0

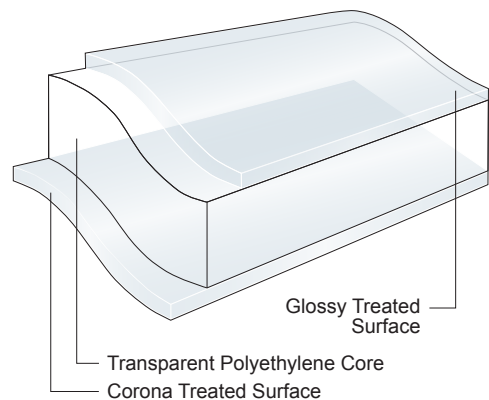

## HD800

High barrier, transparent, bi-axially oriented polyethylene film (HDPE). One side coated with EVOH, it provides excellent gas and aroma protection in duplex laminates. Designed for best performance in printing (rotogravure, flexo) and laminating with PE sealing films. Wide operating windows in heat seal packaging processes. For fully recyclable, high barrier, Mono PE packaging solutions.

**Key Markets :** Salty Snacks, Nuts, Dried Fruits, Dried Pet Food, Household Products, Detergents, Dry Foods, Beverage Powders.

**Packaging Formats :** HFFS, VFFS, Pre-made Bags, Stand-up Pouches.

Thickness (µm)	Unit Weight (g/m <sup>2</sup> )	WVTR (g/m <sup>2</sup> /day)	O <sub>2</sub> TR (cc/m <sup>2</sup> /day)
25	23,60	5,0	1

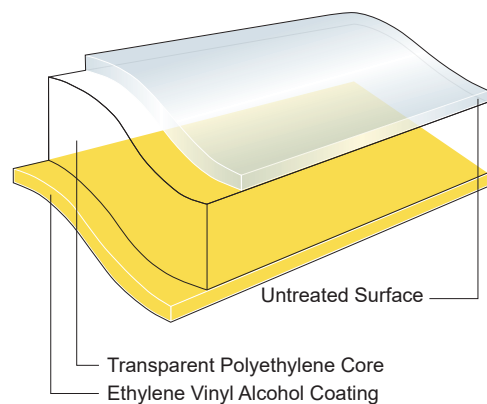

## HD813

High barrier, transparent, bi-axially oriented high density polyethylene (HDPE) films. Coated on one side with EVOH, which is suitable for reverse printing; corona treated on the other side for application of over lacquer, like matte varnish or thermal resistant lacquer. HD813 provides excellent gas and aroma protection in laminates. Designed for best performance in printing (rotogravure, flexo) and laminating with PE sealing films (2-ply or 3-ply laminates). Wide operating windows in heat seal packaging processes. For fully recyclable, high barrier, Mono PE packaging.

**Key Markets :** Salty Snacks, Nuts, Coffee, Dried Fruits, Dry Pet Food, Beverage Powders, Fresh Food, Dairy Products, Household Products, Detergents.

**Packaging Formats :** HFFS, VFFS, Pouches, Stand-up Pouches, Pre-made Bags.

Thickness (µm)	Unit Weight (g/m <sup>2</sup> )	WVTR (g/m <sup>2</sup> /day)	O <sub>2</sub> TR (cc/m <sup>2</sup> /day)
25	23,4	5,0	1

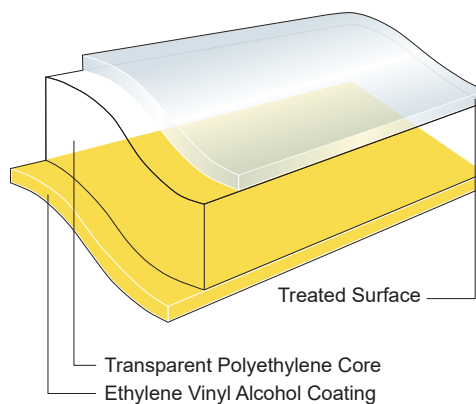

## HDM880

Ultra-high barrier (UHB), two side process-able bi-axially oriented high density polyethylene (HDPE) film, one side metallized and one side treated. This film provides an excellent water vapor barrier as well as an exceptional barrier to oxygen, flavors, aromas and mineral oils. Designed for use as a center web in triplex laminates, to replace e.g. metallized polyester films or even Al foil. For fully recyclable mono-PE packaging solutions.

**Key Markets :** Nuts, Coffee, Baked Goods, Salty Snacks, Dried Fruits, Dry Pet Food, Beverage Powders.

**Packaging Formats :** HFFS, VFFS, Pouches, Stand-up Pouches.

Thickness (µm)	Unit Weight (g/m <sup>2</sup> )	WVTR (g/m <sup>2</sup> /day)	O <sub>2</sub> TR (cc/m <sup>2</sup> /day)
25	23,4	0,2	1

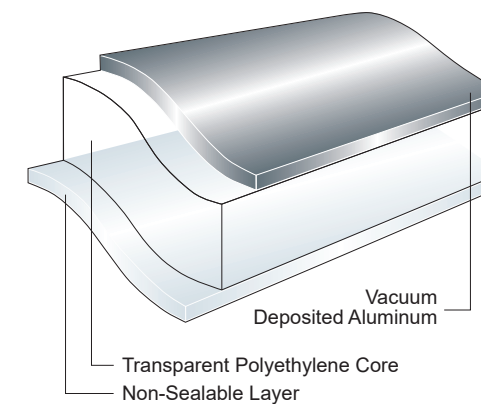

## Flexible Packaging Films

### Heat Seal Range (°C) Measuring Details













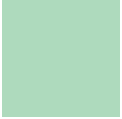



- \* Temperature range to achieve 300 g/25 mm seal force when sealed with flat jaws at 25 N/cm<sup>2</sup> pressure and 0,5 s dwell time
- \*\* Temperature range to achieve 1,0 N/15mm seal force when sealed with flat jaws at 10 N/cm<sup>2</sup> pressure and 0,5 s dwell time

### Product thickness

Thickness is a general product reference and may or may not be the actual finished thickness of the product; see product data sheet.

# Flexible Packaging Films

## Films Illustrations Colour Coding

	<b>Glossy Finish Layer or Treated Surface</b>		<b>Polyvinylidene Chloride Coating (PVdC)</b>		<b>Broad Seal Range Layer (PE)</b>
	<b>Heat Sealable Layer</b>		<b>Acrylic Coating</b>		<b>Vacuum Deposited Aluminum</b>
	<b>Broad &amp; Very Broad Seal Range Layer</b>		<b>Humidity Resistant Coating</b>		<b>Vacuum Deposited Aluminum Oxide (Al<sub>2</sub>O<sub>3</sub>)</b>
	<b>Enhanced Heat Sealable Layer</b>		<b>Polyvinyl Alcohol or Ethylene Vinyl Alcohol Coating (PVOH/EVOH)</b>		<b>100% White</b> <b>White Opaque Cavitated Polypropylene Layer</b>
	<b>Low &amp; Very Low Temperature Seal Coating (LTS/VLT)</b>		<b>Matt Finish Layer</b>		<b>50% White</b> <b>White Layer</b>
	<b>Glossy Release Layer</b>		<b>PE Compatible Heat Sealable Layer</b>		<b>100% Clear</b> <b>Transparent Layer</b>



[www.jindalfilms.com](http://www.jindalfilms.com)

September 2024

© 2024 Jindal Films. Jindal Films, the Jindal Films' logo, and other product or service names used herein are trademarks of Jindal Films, unless indicated otherwise. You may not upload, display, publish, license, post, point to, frame, transmit or distribute either this document or its information, whether in whole or in part, without Jindal Films' prior written authorization. To the extent Jindal Films provides prior written authorization, the user may use the document or its information only if the document is unaltered and complete, including all of its headers, footers, disclaimers and other information. Any data included herein may be based upon: analyses of representative samples and not the actual product shipped, typical values, or otherwise. The information in this document relates only to the named product or materials when not in combination with any other product or materials. We base the information on data believed to be reliable, but we do not represent, warrant, or otherwise guarantee the accuracy, reliability, or completeness of this information; nor do we warrant, expressly or impliedly, the merchantability, fitness for a particular purpose, freedom from patent infringement, or suitability of the products, materials or processes described. The user is solely responsible for all determinations regarding any use of material or product and any process in its territories of interest. We expressly disclaim liability for any loss, damage or injury directly or indirectly suffered or incurred as a result of, or related to, anyone using or relying on any of the information in this document. This document is not an endorsement of any non-Jindal Films' product or process, and we expressly disclaim any contrary implication. The terms "we," "our," "Jindal Films" and "Jindal" are each used for convenience, and may include Films Americas LLC, Jindal Films Americas LLC, Films Europe S.à.r.l., Jindal Films Virton SPRL, Jindal Films India Ltd., or any companies affiliated with them in the production and sale of film products. There are a number of such affiliated companies, some with names including "Jindal" or "Films" and some not. Neither these terms and conditions, nor anything else in this document, is intended to override or supersede the legal separateness of those affiliated companies and responsibility for local action and accountability remains with them.

## JFE

11, rue de l'Industrie  
L-8399 Windhof  
Luxembourg  
T.+352 45 102211  
[info@jindalfilms.com](mailto:info@jindalfilms.com)